

Apollo GX60/65 Quick Reference Guide

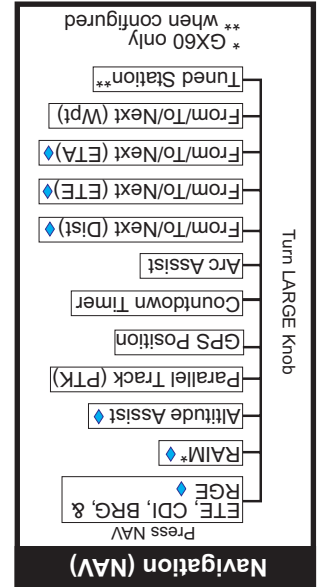
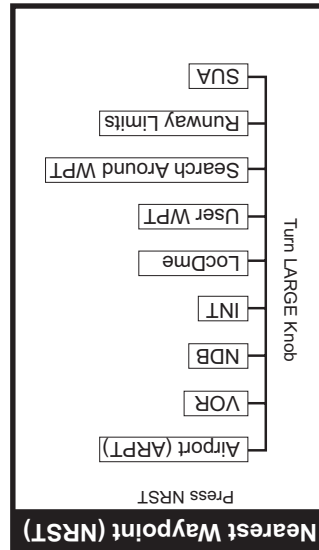
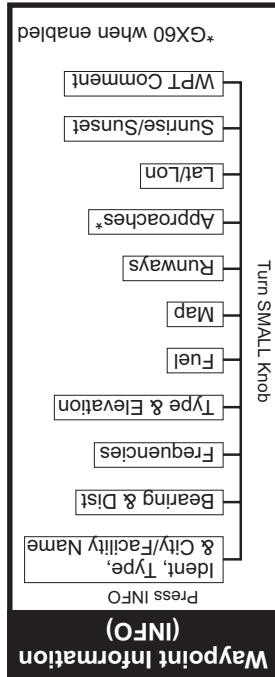
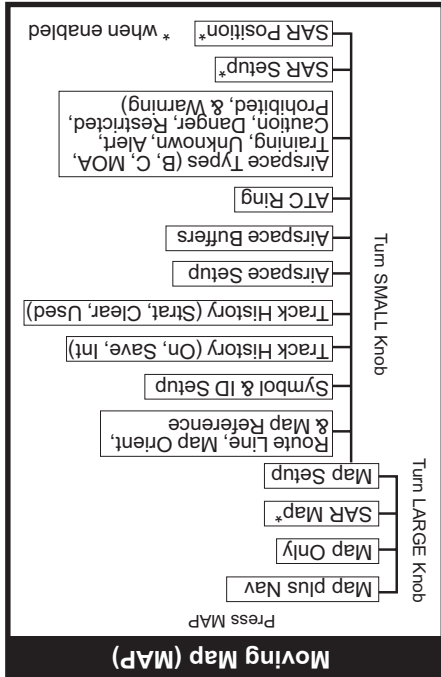
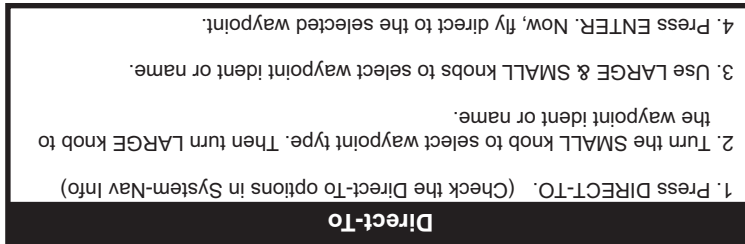

Press SEL to edit information or to select options.

Press ENTER to enter and save information. In the Comm function, ENTER saves the Standby frequency.

Press DIRECT-TO to define a direct course from your present position to a selected waypoint.

Press the indicated key and then turn the LARGE knob to view the pages shown. Turn the SMALL knob for more info when available (diamond shown).



Creating a Flight Plan

1. Press FPL. Turn LARGE knob to the "Create New Flight Plan" page and then press ENTER.
2. To enter a new plan name, press SEL.
3. Turn the SMALL knob to select characters. Turn the LARGE knob to move to the next character.
4. Press ENTER when the name is complete.
5. Turn the SMALL knob to start inserting waypoints into the flight plan. At the INS? prompt, press ENTER.
6. Turn the SMALL knob to select the first character. Turn the LARGE knob cw to move to the next character.
7. Use the SMALL and LARGE knobs to select the waypoint name and then press ENTER.
8. The INS? prompt will flash for the next waypoint. Press ENTER and repeat steps 5-7 until finished.
9. Press SEL to stop editing your flight plan.

Activating a Flight Plan

1. Press FPL.
2. Turn the LARGE knob to the desired active flight plan and press SEL.
3. Turn the SMALL knob to select the desired option and press ENTER.

Creating A New Waypoint

1. Press DB.
2. Turn LARGE knob to the Create User Wpt By Lat/Lon page and then press ENTER.
3. Use the SMALL to select characters and turn the LARGE knob to move the cursor to set the waypoint name.
4. Continue to select the necessary characters for the Lat/Lon and runway length.
5. Press ENTER when finished.

Finding Info On A Waypoint

1. Press DB.
2. Turn the LARGE knob to the Access Database page and press ENTER.
3. Turn the SMALL knob to select waypoint type.
4. Turn the LARGE knob to the desired character and turn the SMALL knob to select characters.
5. Press INFO.
6. Turn the SMALL knob to view information.
7. Press INFO again or ENTER to exit.

Emergency Search

1. Press NRST.
2. Turn the LARGE knob to change Wpt type.
3. Turn the SMALL knob to view nearby waypoints.
4. Press DIRECT-TO and then ENTER to fly direct to the wpt.



Approach Setup Summary

A. Load Destination Airport

Load a destination airport. Load a stored Flight Plan, or edit the active Flight Plan. You may also use the DIRECT-TO button to choose a destination. The destination must be an airport that has an established approach capability.

B. Load Approach Information

1. Press FPL twice to reach the home page Flight Plan Mode and press SEL, or press SEL while in the Nav function.
2. Press ENTER to prepare to load approach waypoints.
3. Turn the SMALL knob to display the available approach choices.
4. Press ENTER to select the displayed approach path.
5. Turn the SMALL knob to display the approach legs.
6. Press NAV to return to Navigation Mode.

GX60 Only

Approach Checklist

Location	Action
Enroute	Load Approach
Within 30 nm of Destination	Enable Approach & enter altimeter setting (Approach annunciator turns ON) (CDI goes to 1 nm full-scale sensitivity)
IAF Active Waypoint	Verify Approach annunciator is ON Verify/Set OBS/HLD: ON for Procedure Turn or Hold OFF to sequence
FAF Active Waypoint	Verify green Approach-Active annunciator is ON Verify altimeter setting is entered Verify/Set OBS/HLD: OFF to sequence to MAP
At FAF (MAP Becomes Active)	Verify Approach-Active annunciator is ON (CDI goes to 0.3 nm full-scale sensitivity)
At MAP (TO/FROM Transition)	If NOT landing: Press OBS/HLD to cancel Approach-Active (Green Approach-Active annunciator turns OFF) (Approach Annunciator remains ON) (CDI goes to 1.0 nm full-scale sensitivity)
MAHP Active Waypoint	Verify OBS/HLD is ON GX60 Only

DME-Arc Checklist

Location	Action
At Arc Intercept	1. Verify/Set OBS/HLD ON 2. USE DME-Arc Page in NAV mode 3. Verify or select DME-Arc Reference Waypoint and follow the prompts 4. Use Nav or Map mode and follow information
On Arc	1. Use DME-Arc page in NAV mode or Map mode to navigate 2. Follow prompts for inbound leg intercept
Inbound Leg Intercept	1. Follow prompts to turn to next leg GX60 Only

Messages (MSG)

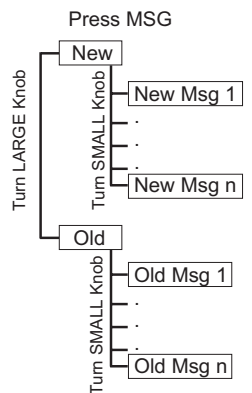

Database (DB)

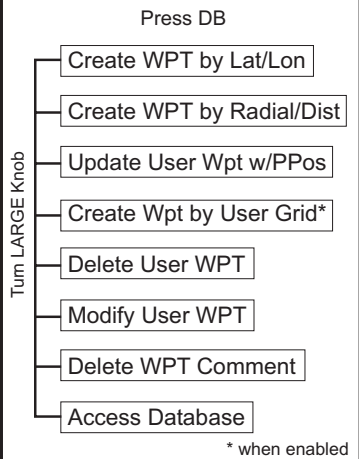

Flight Plan (FPL)

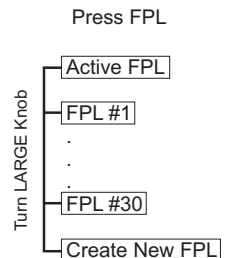

Comm Radio (COM)

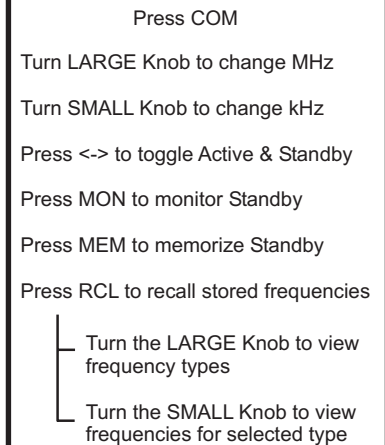

System (SYS)

Press SYS. Turn LARGE Knob, then press ENTER.

